



## EUROPE IN THE SECOND CENTURY OF AUTO-MOBILITY

### Reliable Vehicle Dynamics Simulation in Spite of Uncertain Input Data

Wolfgang Hirschberg<sup>1</sup>, František Palčák<sup>2</sup>, Georg Rill<sup>3</sup>, Jan Šotník<sup>2</sup>

<sup>1</sup> Graz University of Technology, Austria

<sup>2</sup> Slovak University of Technology Bratislava, Slovakia

<sup>3</sup> University of Applied Science Regensburg, Germany

#### ABSTRACT

The mission of this paper is to demonstrate the contribution of the tyre model TMeasy to reliable and accurate full-vehicle dynamic simulations, which are carried out in the MSC.Adams environment. Increasing demands in accuracy and reliability of vehicle dynamics simulations require refinements of the models, particularly of the tyre models. On the other hand, however, there is still a lack of reliable tyre input data, which does hardly correspond to the achieved level in tyre modelling. Remarkable deviations of the measured tyre data from the tyre's capacities on a real roadway are caused by the testing procedure itself as well as by the testing conditions. As one pragmatic approach, lean semi-physical tyre modelling may help to overcome this shortcut, if the set of tyre model parameters is manageable and has got clear physical meaning. Simulations are increasingly supported by prototype measurements in the advanced stages of development. It is crucial for the simulation to react quickly to the engineering development steps. However, even is that phase not all of the necessary input data is complete and sufficient.

Based on a passenger car application, the procedure of parameter identification and estimation respectively is shown in the paper. The availability and sensitivity of the main parameters are qualitatively classified. Finally, the comparison of simulation results with measurements from testing manoeuvres allows it to rectify the chosen assumptions.

**KEYWORDS:** Vehicle, tyre, modelling, dynamics simulation.

#### INTRODUCTION

The great importance of simulation in the in the early stages of automotive vehicle development process is evident and great effort is still spent to advance the methods with respect to reliability and accuracy. In the field of vehicle dynamics simulation, multibody systems (MBS) have established themselves as the essential method for modelling. Although a high quality level of complex full vehicle models could be achieved there is still a remarkable lack of certain input data to feed the parameters of the models. One can observe an ever increasing inadequacy between refinement of the applied models and the quality of the available input data. Particularly in the important field of tyre modelling an apparent lack of certain testing data has to be mentioned. It is a well know fact that the process of data acquisition is much more time consuming than the work of modelling and simulation itself.

In order to classify the operating expense of data acquisition one can introduce four levels A - D of availability of model parameters as shown in Table 1. it is a know experience that in the same degree of increasing expenses of the data acquisition the effort for identification of the model parameters can be expected.

Availability	Type of parameter	Source
A moderate	Geometrical data, masses, spring stiffness	CAD CAD, balance; simple equipment
B medium	Position of centres of gravity, damper characteristics; body stiffness	Measurement equipment; linear FEM
C difficult	Tyre force and moment characteristics, spatial stiffness and damping of - elastomere bushings, - air springs, leaf springs, friction parameters, inertia tensor of vehicle body	Specific test benches; supplier; nonlinear FEM  CAD, DMU
D none	ECU control procedures	(Supplier)

**Table 1:** Classification of MBS-parameters with respect to availability

For the dynamic simulation of automotive vehicles, the model element "tyre/road" is of special importance, according to its direct influence on the achievable results. It can be said that the sufficient description of the interactions between tyre and road is one of the most important tasks of vehicle modelling, because all the other components of the

chassis influence the vehicle dynamics properties via the tyre contact forces and torques. Therefore, in the interest of balanced modelling, the precision of the complete vehicle model should stand in reasonable relation to the performance of the applied tyre model, [1]. Therefore, the present paper focuses on the aspect of the entire process of tyre modelling from the testing data source via parameter identification to MBS implementation.

### TESTING DATA FOR TYRE MODELS

As already mentioned in [1], in engineering practice often there exists the problem of data availability for a special type of tyre for the examined vehicle. Considerable amount of experimental data for car tyres has been published or can be obtained from the tyre manufacturers. If one cannot find data for a special tyre, its characteristics can be estimated at least by an engineer's interpolation of similar tyre types. In the field of truck tyres there is still a considerable backlog in data provision. These circumstances must be respected in conceiving a user-friendly tyre model. For a special type of tyre, usually the following sets of experimental data are provided:

- longitudinal force versus longitudinal slip (mostly just brake-force),
- lateral force versus slip angle,
- aligning torque versus slip angle,
- radial and axial compliance characteristics,

whereas additional measurement data under camber and low road adhesion are rather favourable special cases. Any other correlations, especially the combined forces and torques, effective under operating conditions, often have to be generated by appropriate assumptions with the model itself, due to the lack of appropriate measurements. Another problem is the evaluation of measurement data from different sources (i.e. different measuring techniques) for a certain tyre. It is a known fact that different measuring techniques result in widely spread results. Particular differences are seen in testing data from drum and flat tape test benches. Another source of irregularities is given by the artificial roughened testing surface. Here the experience of the user is needed to assemble a "probably best" set of data as a basis for the tyre model from these sets of data, and also to verify it eventually with own experimental results.

The above mentioned problems concern the steady state tyre characteristics. For transient applications in vehicle simulation additional testing data describing at least the tyre dynamics of first order would be very helpful. Because of usual lack of such data it is obviously important to describe dynamic tyre effect out from other available parameters under avoidance of any data fitting procedure.

Tyre models can be subdivided into three classes of modelling approach:

- **Physical tyre models** with focus on rough road application and comfort simulation. Physical tyre models aim at a 3D-description of the nonlinear and rotation dependent tyre dynamics. Particularly they describe the adhesion mechanisms between the contact patch and the roadway. Their numerous model parameters are vast physical ones, but it is hardly possible to fit a reliable parameter set without aid of the model suppliers, [5]. Concerning simulation effort, they are more or less computation time consuming.
- **Phenomenological (mathematical-empirical) tyre models** which aim to vehicle dynamics and handling. They fit measured tyre characteristics without modelling of the physical background. Such they depend a-priori on the availability of a complete set of reliable testing data. Their model parameters satisfy certain functional approaches without any physical meaning. So it is quite difficult to adjust the parameter set to a similar tyre type without measurements.
- **Semi-physical tyre models** which also used for vehicle dynamics and handling. They aim to combine the advantages of the above mentioned modelling techniques, namely to apply closed algebraic approaches with a lean parameter set of physical meaning and to have well runtime behaviour even with real time capability.

In order to overcome the practical restrictions of incomplete and uncertain tyre measurement data it is recommendable to apply semi-physical tyre modelling. In the following, the process of building up a full vehicle model of an Opel Combo 1.6 CNG is shown, where the vehicle is modelled in MBS-system MSC.Adams [6] under application of the semi-physical tyre Model TMeasy [1].

### MODEL OF A PASSENGER CAR

For the investigations an Opel Combo 1.6 CNG ecoFLEX 69KW/94PS was applied, which is a light commercial vehicle, Fig. 1. As front axle, the vehicle is equipped with independent McPherson struts with gas pre-loaded dampers and an anti roll bar. At the rear, a twist beam axle with coil springs and gas-filled shock absorbers serve as wheel suspension. The empty mass of the vehicle is 1210 kg. With the maximum allowed payload of 520 kg the gross vehicle mass yields 1730 kg. The vehicle is equipped with radial tyres Continental 185/60 R15 under inflation pressure of 2.6 bar.



**Fig. 1:** Testing vehicle with measurement equipment

The full vehicle model is build up as multibody system (MBS) in the simulation software MSC.Adams/Car [6], see Fig. 2. The model consists of about 50 parts with 37 degrees of freedom (DOF) and it is briefly described in the following.

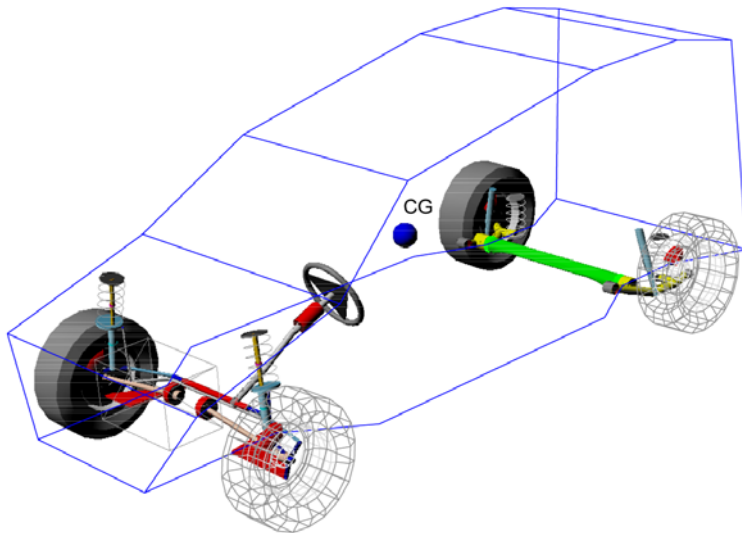

**Fig. 2:** MBS full model of the vehicle

The vehicle body is built up as rigid part. The engine, gearbox and differential are modelled as a single power unit part that is fixed to the part chassis. Such the relative motion between them is suppressed according to interesting low frequency domain of

vehicle dynamics. The brake system is taken into account as a controlled torque which is applied on each wheel counter-clockwise to the spin velocity of the wheel.

The McPherson front suspensions represent a standard design featured with rigid lower control arms. The wheel carriers include the wheel bearings and connect the lower control arms with the struts and the tie rods which control the steering motion of the wheel. All these parts are connected together with joints as geometrical constraints. Springs and dampers are represented as nonlinear force elements, using ADAMS/Solver SFORCE routines, which interpolate a force versus deflection table for the spring and force versus velocity table for the damper. The front anti roll bar consists of two rigid bars, where a torsion spring acts between them. The bars are mounted by revolute joints to the chassis and by side bars with spherical joints to the upper parts of each of the struts.

The rack and pinion steering gear translates the rotational motion of the steering wheel into the linear translation of the rack which is brought forward to the wheel carriers via rigid steering rods. The steer angle of the vehicle is controlled either trajectory based (closed loop mode) or based on a certain input signal (open loop mode), the steering wheel can be driven by angle and/or torque input.

The twist beam suspension represents a widely used rear wheel axle. The axle sub-model consists of two rigid trailing arms, one at each side, connected by a flexible FEM crossbeam bushing. The shell elements of the flexible body have got 16562 nodes and there are the first 32 mode shapes considered in order to simulate the elastic behaviour of the structure. As one important element for the correct side slip behaviour of the vehicle while turning, the spatial stiffness of the bushings which connect the twist beam axles with the vehicle's body have to be modelled. Similar to the front axle, the rear springs and dampers are represented as force elements, using the ADAMS/Solver SFORCE routines, see above.

All four wheels are built up as rigid rims and hubs with the overall mass and inertia properties of the wheel. The tyre is modelled as an external force element, described by the semi-physical tyre model TMeasy, which acts between the road and the rim. The basics of the model and the procedure of application are briefly described in the following.

## SEMI-PHYSICAL TYRE MODEL

### Contact Geometry

Within TMeasy it is assumed that the contact patch is sufficiently flat. Four road points  $Q_1$  to  $Q_4$  located in the front, in the rear, to the left and to the right of the tyre patch are used to define the normal vector  $e_N$  of a local track plane and to calculate the geometric contact point  $P$  on rough roads, Fig. 3. As in real tyre-road contact, sharp bends and dis-

continuities, which will occur at step- or ramp-sized obstacles, are smoothed by this approach.

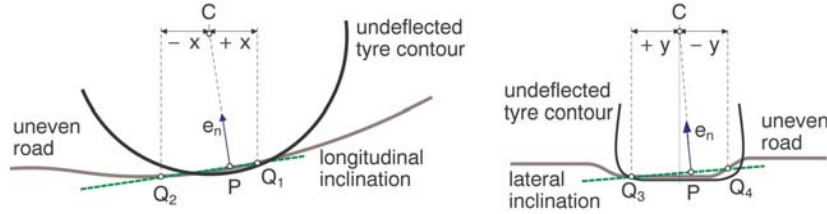

**Figure 3:** Track normal and geometric contact point on uneven roads

The direction of the longitudinal and lateral forces as well as the tyre camber angle are then derived from the direction of the wheel rotation axis and the track normal.

The tyre deflection  $\Delta z$  which normally is the difference between the undeflected tyre radius  $r_0$  and the static radius  $r_s$  is calculated via equivalent deflection areas on a cambered tyre, Fig. 4.

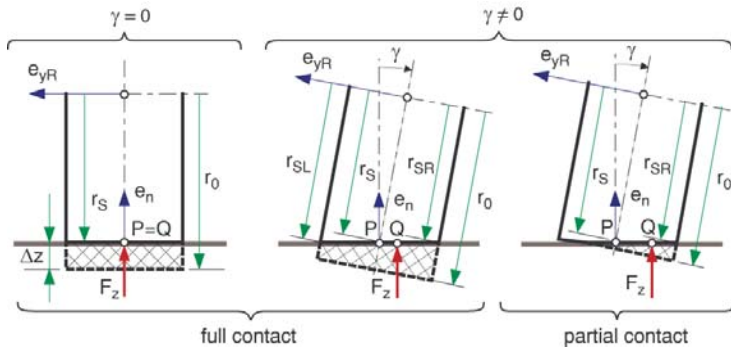

**Figure 4:** Tyre deflection and static contact point

In consequence the geometric contact point  $P$  is shifted to the static contact point  $Q$  where the resulting wheel load  $F_z$  will be applied.

By taking into account that the tyre deformation consists of the belt and flank deformation a realistic approximation of the length  $L$  of the contact patch is possible. The dynamic rolling radius  $r_D$  of the tyre which is needed for average transport velocity of tread particles is calculated by a weighted sum of the undeflected and the static tyre radius.

**Steady State Tyre Forces**

The normal force or wheel load is separated into a static and a dynamic part:

$$F_z = F_z^S + F_z^D . \tag{1}$$

The static part  $F_z^S$  is described as a nonlinear function of the tyre deflection  $\Delta z$  and the dynamic part  $F_z^D$  is roughly approximated by a damping force proportional to the time derivative  $\Delta \dot{z}$  of the tyre deflection. Because the tyre can only apply pressure forces to the road the normal force is restricted to  $F_z \geq 0$ .

The longitudinal force as a function of the longitudinal slip  $F_x = F_x(s_x)$  and the lateral force depending on the lateral slip  $F_y = F_y(s_y)$  are defined by characteristic parameters: The initial inclination  $dF_x^0, dF_y^0$ , the location  $s_x^M, s_y^M$  and the magnitude of the maximum  $F_x^M, F_y^M$  as well as the sliding limit  $s_x^S, s_y^S$  and the sliding force  $F_x^S, F_y^S$ , Fig. 5.

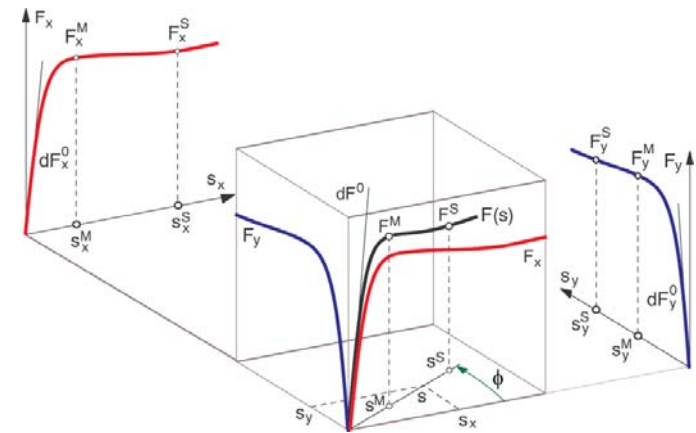

**Figure 5:** Generalised tyre characteristics

By combining the longitudinal and lateral slip to a generalised slip  $s$  the combined force characteristics  $F = F(s)$  can be automatically generated by the characteristic tyre parameters in longitudinal and lateral direction, [1]. In general driving situations, e.g. acceleration or deceleration in curves the longitudinal and lateral tyre forces are the given by the projection of the generalised force characteristic into the longitudinal and lateral direction

$$F_x = F \cos \varphi = F \frac{s_x^N}{s} = \frac{F}{s} s_x^N \quad \text{and} \quad F_y = F \sin \varphi = F \frac{s_y^N}{s} = \frac{F}{s} s_y^N \tag{2}$$

where the normalised slip quantities  $s_x^N$ ,  $s_y^N$  are used to improve the combined force modelling.

The self-aligning torque is approximated via the pneumatic trail which again is described by characteristic parameters. The influence of the camber angle to the lateral tyre force and the self-aligning torque is modelled by an equivalent lateral slip and by a bore torque which is generated by the component of the wheel rotation around an axis perpendicular to the local track plane.

The mostly degressive influence of the wheel load to the steady state tyre forces and torques is taken into account by defining all characteristic tyre parameters for the payload of the tyre and its double value.

### First Order Tyre Dynamics

Measurements show that the dynamic reaction of the tyre forces and torques to disturbances can be approximated quite well by first order systems, [2]. Taking the tyre deformation into account the TMeasy approach for steady state tyre forces can easily be extended to dynamic tyre forces. The tyre forces  $F_x$  and  $F_y$  acting in the contact patch deflect the tyre in longitudinal and lateral direction, Fig. 6.

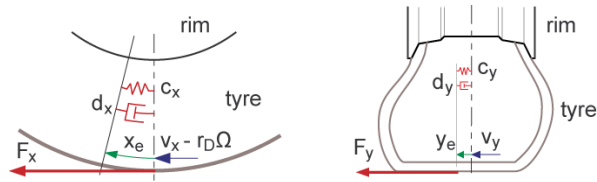

**Figure 6:** Tyre deflection in longitudinal and lateral direction

In a first order approximation the dynamic tyre force  $F_x^D$  in the longitudinal direction yields

$$F_x^D = F_x(v_x + \dot{x}_e) \approx F_x(v_x) + \frac{\partial F_x}{\partial v_x} \dot{x}_e \approx F_x^S + \frac{\partial F_x}{\partial v_x} \dot{x}_e, \quad (3)$$

where  $x_e$  names the elastical longitudinal tyre deflection and the steady state tyre force  $F_x^S$  in longitudinal direction is provided by Eq. (2). On the other hand, the dynamic tyre force can be derived from

$$F_x^D = c_x x_e + d_x \dot{x}_e, \quad (4)$$

where  $c_x$  and  $d_x$  denote linear stiffness and damping properties of the tyre in the longitudinal direction. Combining Eqs. (3) and (4) finally results in a first order differential equation for the longitudinal tyre deflection

$$\left( d_x r_D |\Omega| s_x + \frac{F}{s} \right) \dot{x}_e = -\frac{F}{s} (v_x - r_D \Omega) - c_x x_e r_D |\Omega| \hat{s}_x, \quad (5)$$

where  $r_D$  names the dynamic rolling radius of the tyre,  $\Omega$  is the angular velocity of the wheel and  $\hat{s}_x$  denotes the normalisation factor of the longitudinal slip.

The modelling of the lateral tyre force dynamics is straight forward. A dynamic model of the bore torque which is needed for simulating the parking effort is described in [4].

This principally simple but effective extension to first order dynamic tyre forces and torques allows a smooth transition from normal driving situations to stand still and keeps the dynamics of the system in a finite state.

### IMPLEMENTATION AND APPLICATION

The implementation of TMeasy into Adams is done via the Standard Tyre Interface (STI), [3]. This interface in current version 1.4 is supported today by most of the commercial simulation systems and allows the link of any STI-compatible tyre model, as far as they represent per definition vehicle dynamic models with an idealised contact point, Fig. 7.

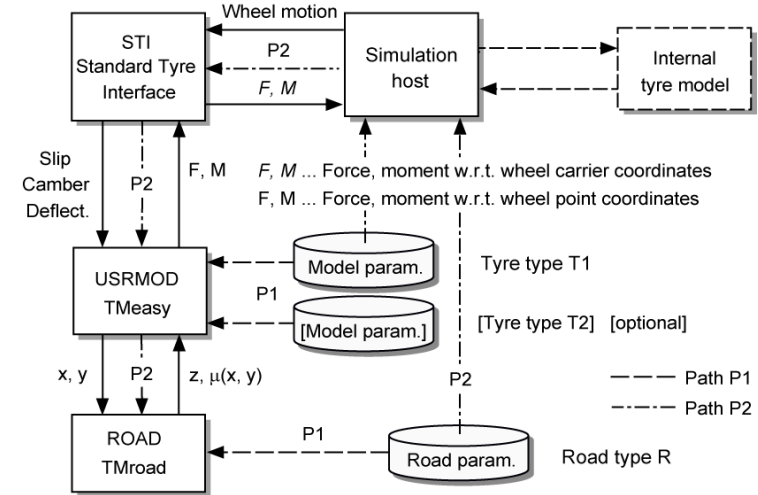

**Figure 7:** Implementation of TMeasy into the MBS program

The simulation program processes the wheel motion values in the sequence of the vehicle's wheels  $W_i$ ,  $i = 1, 2 \dots n_W$  at every time step to STI, which are here transformed into the internal motion values of the applied tyre model and then passed to it. As output, STI delivers the actual vectors of the tyre forces  $F_i$  and torques  $M_i$  in the specified form

back to the simulation program. On necessity, from there they can be passed on to the according post processor as well as additional tyre variables for any control purpose.

The coefficients of the chosen tyre type(s) and the road parameters or data respectively, e.g. road geometry and friction distribution  $[z, \mu] = f_R(x, y)$  are provided via independent model data. There are two different ways to forward the model parameters. One may prefer the direct import of the needed data from the selected tyre and road parameter files such as depicted as path P1 in Fig. 14. The other way is to pass the set of parameters directly from the simulation host's pre-processor via the therefore reserved parameter arrays to the tyre model, marked as path P2.

A complete set of parameters for a vehicle model thus consists of at least one road file and one tyre file for each group of identical vehicle tyres, therefore, at least of one tyre file. The correct assignment of the tyre to its related model body `wheel#i` is defined in the model file and again this is directed by ST1.

Within TMeasy the contact force characteristics in longitudinal and lateral direction are described by a handful of physical parameters, which takes the degressive influence of decreasing tyre load into account. The load influence can be easily described by providing these parameters for the nominal payload and its double value, Table 2.

```

$-----
[LATERAL_PARAMETERS]
DFY0_1 = 69000.    $ init slope @ FZ_NOM [N]
FYMAX_1 = 3200.   $ max force @ FZ_NOM [N]
SYMAX_1 = 0.210   $ sy where fy(sy) = FYMAX_1
FYSLD_1 = 3100.   $ sliding force @ FZ_NOM [N]
SYSLD_1 = 0.600   $ sy where fx(sx) = FYSLD_1
$-----
DFY0_2 = 100000.  $ init slope @ 2*FZ_NOM [N]
FYMAX_2 = 5800.   $ max force @ 2*FZ_NOM [N]
SYMAX_2 = 0.230   $ sy where fy(sy) = FYMAX_2
FYSLD_2 = 5650.   $ sliding force @ 2*FZ_NOM [N]
SYSLD_2 = 0.600   $ sy where fx(sx) = FYSLD_2

```

**Table 2:** Extract from the TMeasy tyre property file: Lateral force parameters

The two times five parameters, which can easily be changed on demand “by hand” due to their physical meanings are depicted in Fig. 8.

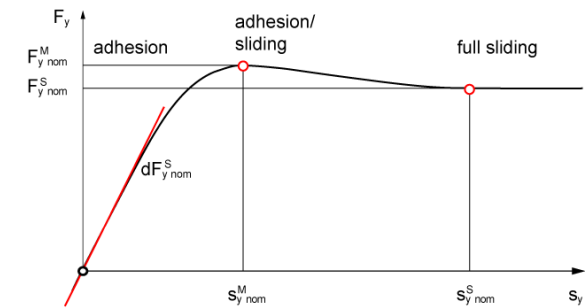

**Figure 8:** Lateral force function with five parameters for  $F_{z,nom}$

## SIMULATION AND MEASUREMENT RESULTS

In the following, two selected Adams/Car - TMeasy applications are shown.

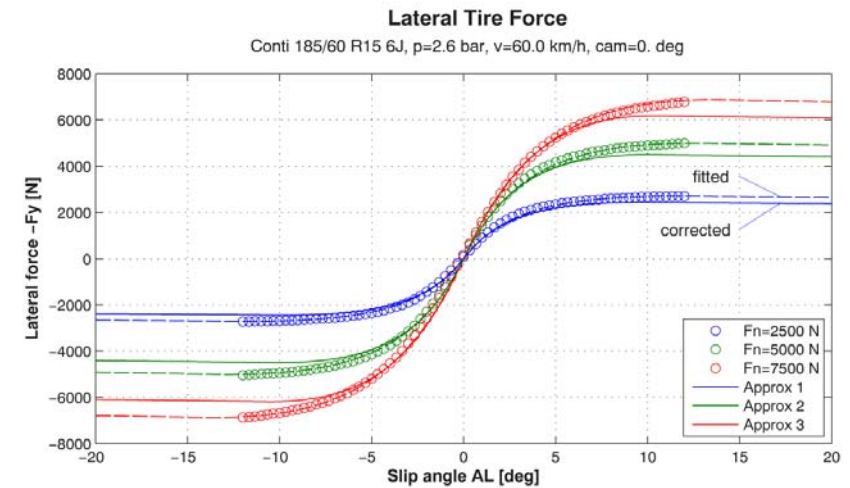
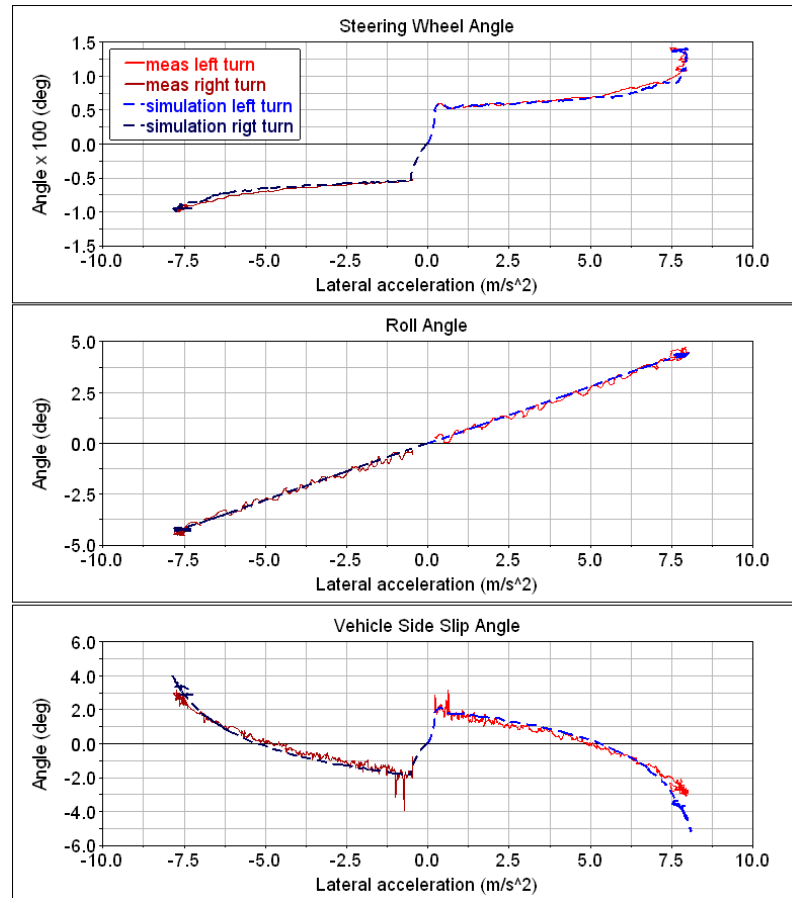

**Figure 9:** Lateral tyre force characteristics: Measured, fitted and corrected data

Firstly, a steady state cornering manoeuvre is considered. This use case is quite helpful to check the quality of the received tyre testing data. In the present case, the testing data for the rather small tyre showed an implausible amount of maximum lateral grip potential of  $\mu_{max} \approx 1.1$ , Fig. 9 which was probably caused by a new safety walk coating of the flat bench test rig. When reducing the nominal road-tyre friction coefficient by 10%, one can

expect satisfactory correlation between simulation and measurement, see Fig. 10.

It should be mentioned that down scaling of grip has to be done without changing the initial lateral stiffness by the tyre model, rather than pure linear scaling. This example shows clearly the risk of any automatic curve fitting procedure without critical check of the data plausibility.



**Figure 10:** Comparison simulation-measurement: Steady state cornering

The testing manoeuvre (multiple) lane change is well qualified to validate the vehicle model and due to its transient nature also for checking the dynamics capabilities of the tyre

model. In the present example, the time series of the measured steering angle is applied on the vehicle model by an input driver. As it can be shown in Fig. 11, the vehicle's responses to these disturbances correlate quite well with the measured signals.

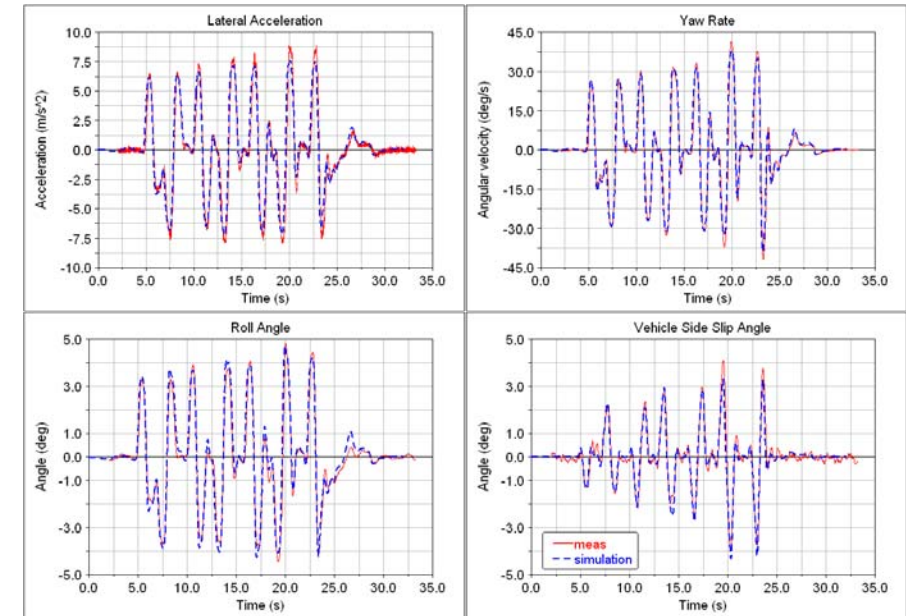

**Figure 11:** Comparison simulation-measurement: Multiple lane change

## CONCLUSIONS

In vehicle dynamics practice often there exists the problem of data availability in order to identify the model's parameters. In the present contribution firstly a raw classification of MBS-parameters with respect to availability is done. Particularly for the tyres of the examined vehicle, which have essential influence on driving dynamics. There is a considerable lack of reliable tyre testing data. Some amounts of experimental data for car tyres has been published or can be obtained from the tyre manufacturers. If one cannot obtain data for a special tyre, its characteristics can be estimated at least by an engineer's interpolation of similar tyre types.

Another problem is the evaluation of measurement data from different sources (i.e. measuring techniques) for a special tyre. It is a known fact that different measuring techniques result in widely spread results. Here the experience of the user is needed to

assemble a “probably best” set of data as a basis for the tyre model from these sets of data, and to verify it eventually with own experimental results. In order to do so, the physical meaning of the parameters of the applied tyre model is an important feature.

Out of experience about the mentioned restrictions the described tyre model TMeasy was conceived, which has been proved successfully in meeting practical requirements and which allows good correlation between simulation and experiment. This procedure is shown by means of a full vehicle model of a light commercial vehicle, which is modelled and verified in the multibody system MSC.Adams environment.

#### **ACKNOWLEDGEMENT**

This contribution was supported by Grant Agency VEGA No.1/0176/08.

The authors are also indebted to thank Continental AG for their friendly support.

#### **REFERENCES**

- [1] Hirschberg, W., Rill, G., Weinfurter, H.: User-Appropriate Tyre-Modelling for Vehicle Dynamics in Standard and Limit Situations. In: Vehicle System Dynamics 2002, Vol.38, No.2, pp.103-125.
- [2] van der Jagt, P.: The Road to Virtual Vehicle Prototyping; new CAE-models for accelerated vehicle dynamics development. Techn. Univ. Eindhoven, 2000, ISBN 90-386-2552-9 NUGI 834.
- [3] van Oosten, J.J.M. et al. TydexWorkshop: Standardisation of Data Exchange in Tyre Testing and Tyre Modelling. Proc. 2nd Int. Colloquium on Tyre Models for Vehicle Dynamic Analysis, Swets&Zeitlinger, Lisse 1997.
- [4] Rill, G.: First Order Tire Dynamics. In: Proceedings of the III European Conference on Computational Mechanics Solids, Structures and Coupled Problems in Engineering. Lisbon, Portugal, 5-8 June 2006.
- [5] Waser, S., Hirschberg, W., Ille, T.: Evaluation and Sensitivity Analysis of Tyre and Road Models for Simulation of Loads on Commercial Vehicles. FISITA World Automotive Congress Munich, 2008. Paper F2008-12-182 (CD Proc.).
- [6] URL: [www.mscsoftware.com/products/adams.cfm](http://www.mscsoftware.com/products/adams.cfm) (called 18.04.2009)  
Webpage of MBS system MSC.Adams.